

CYCLONE SEPARATOR CYGG-180



order number	CYGG-180
optimal inlet pipe size	Ø 180
minimum air flow	1650 m³/h
maximum air flow	1930 m³/h
pressure loss	800 - 1200 Pa
separation	70 - 95%
cyclone height	1600 mm
cyclone diameter	Ø 500
inlet flange dimension	270x90 mm
temperature resistance	150°C
cyclone weight	85 kg
recommended rotary feeder	RPGG 20x20-8
material design	11375
surface protection	lacquered

Description

Cyclone is a mechanical dust separator, which uses centrifugal forces acting on dust particles entrained in the exhaust air to separate the dust. The incoming air-dust mixture enters the cyclone separator at the top - an eccentric inlet, which rotates the mixture around the cyclone axis. Due to the centrifugal force, the dust particles slide on the inner surface of the cyclone separator tube and, due to gravity, are carried downwards to the discharge flange. Air is discharged at the top of the cyclone. For proper functioning of the cyclone, it is necessary to ensure pressure separation of the waste discharge from the surrounding environment in order not to affect the flow inside the cyclone or air leakage through the discharge neck.

Use of cyclone

Cyclone separators are mainly used, due to their lower efficiency in separating finer dust fractions, as pre-separators in front of the filtering device, thereby relieving them from most of the dust. In dust extraction applications from woodworking machines, mainly wet sawdust, cyclones are used as a single separator without subsequent filtration. Cyclone separators are also used in closed circuits of pneumatic transport or in flue ways to pre-isolate sparks before the flue gas enters the filter device. The cyclones can be arranged in parallel side by side, increasing capacity, or serially in succession, increasing separation.

Working conditions

Cyclone separators are designed for separating non-abrasive dust with fraction size up to 50 mm. The working temperature of the suction medium ranges from -30 ° C to + 150 ° C for material version 11 375 and to 250 ° C for material version made of stainless steel. When designing the ventilation system, it is necessary to take into account the pressure loss of the cyclone at the level of 800 to 1200 Pa depending on the quantity and temperature of the exhausted air.

Assembly options

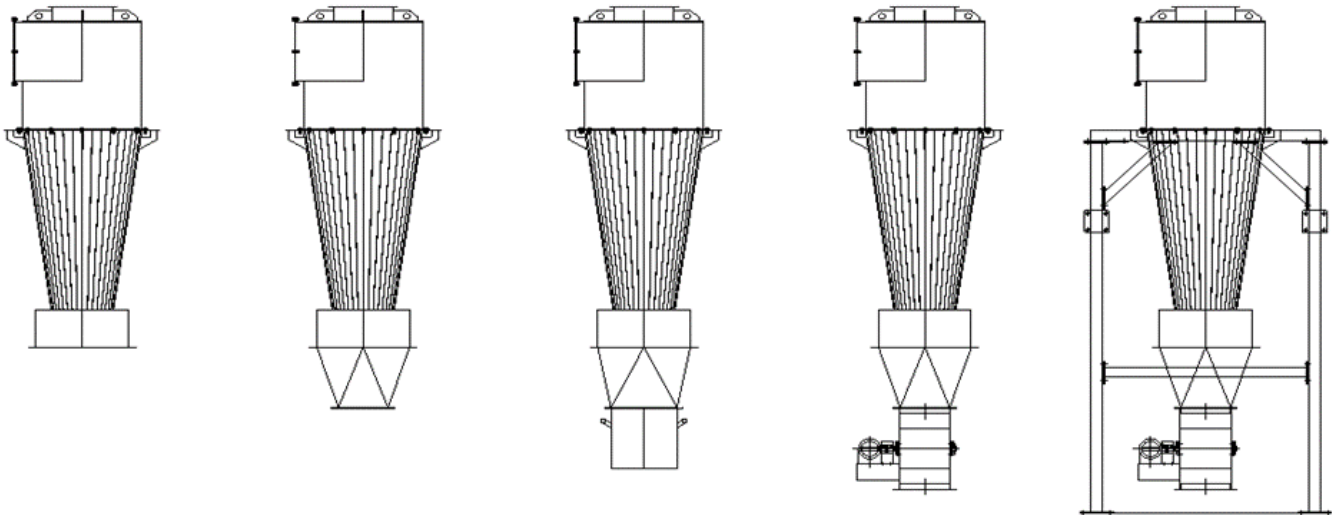

only cyclone cyclone + expansion chamber cyclone with bucket cyclone with rotary feeder assembly with steel construction